

# USER MANUAL OF EBQ (EBQ)

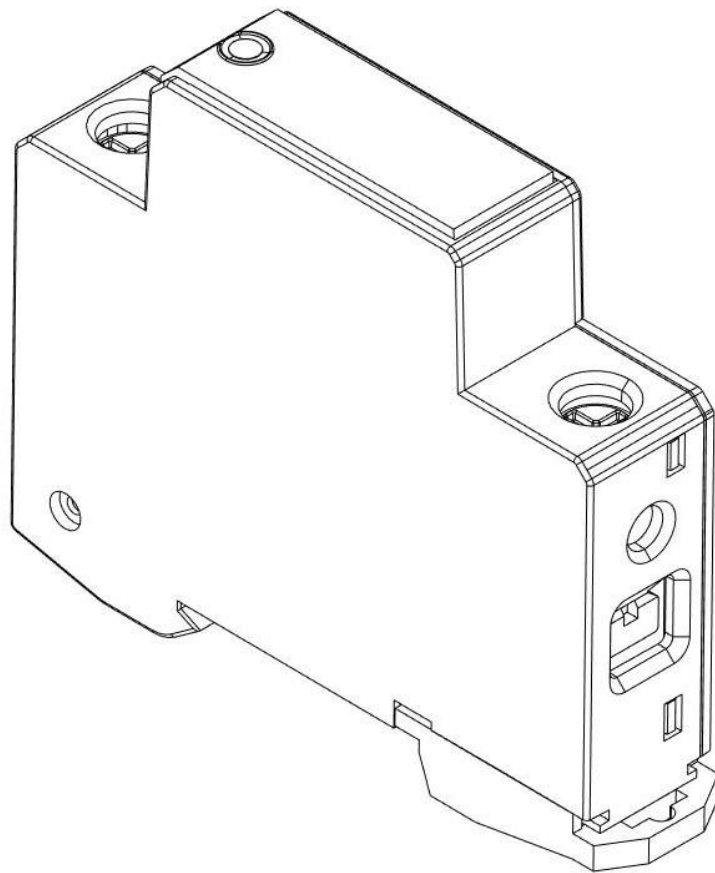

**EBQ**

# INSTALLATION

# 1

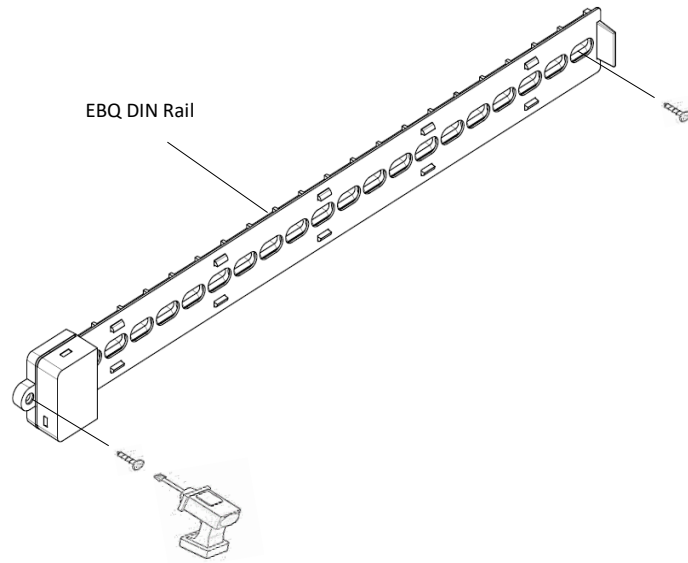

# 2

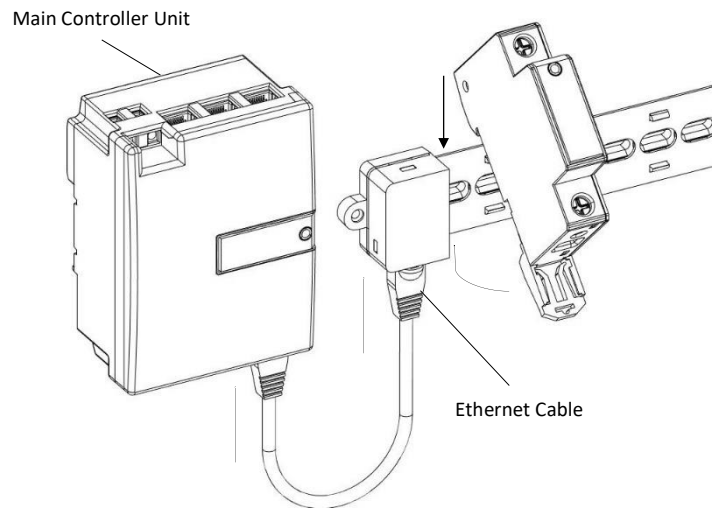

# 3

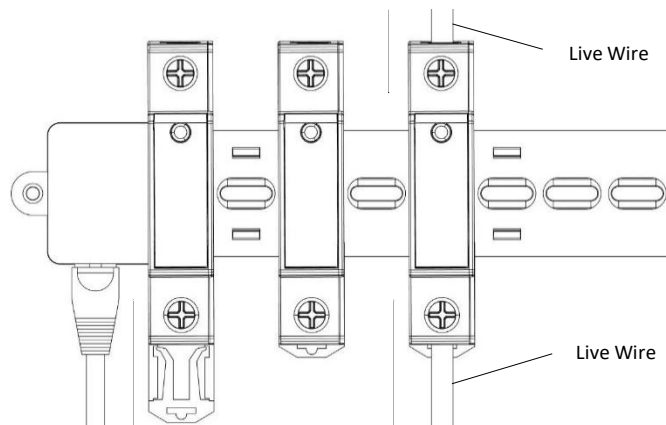

**PRECAUTIONS**

- 1. Distance between 2 EBQ Din Rails are at least 10 cm.

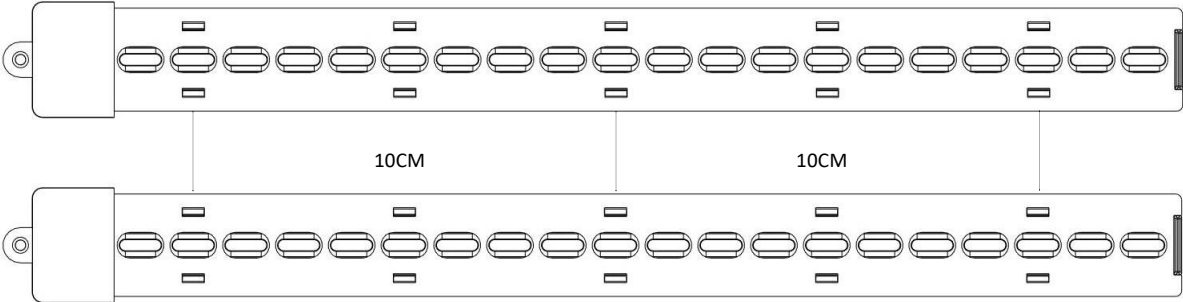

- 2. EBQ Din Rail keep away from metal at least 5 mm.

**INFORMATION**

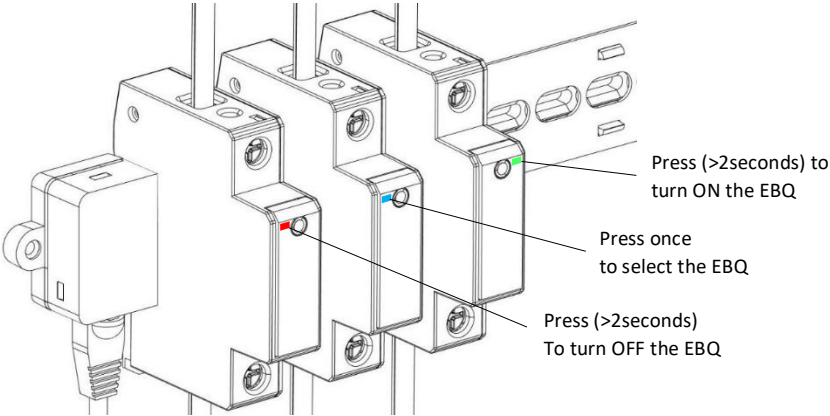
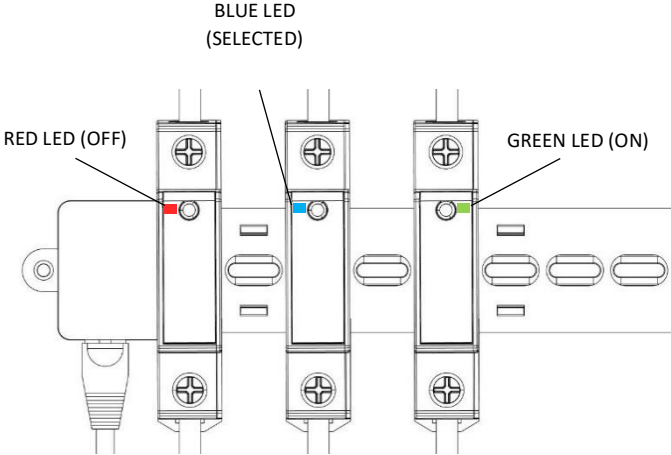

## **SPECIFICATIONS**

Parameter	Remarks	
	EBQ(16A)	EBQ(40A)
Rated Current	1 ~ 16A	1 ~ 40A
Start up Period	1.3 ~ 1.5min	2.5 ~ 3.3min
Operating Voltage	120 ~ 240VAC	
Frequency	50 – 60Hz	
Overvoltage/Undervoltage Breaking Period	0.1 sec	
Operating Temperature	0 ~ 70°C	
Weight	71g	93g
Dimensions	(L x W x H) 83.0 x 18.0 x 70.0 mm	

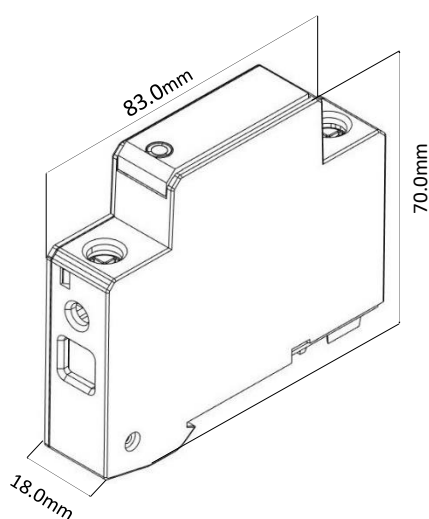

## **SPECIFICATIONS (Master)**

Parameter	Remarks
Operating Voltage	120 ~ 260VAC
Frequency	50 – 60Hz
Maximum Power Rating	15W

## PRE-SETUP

### EBQ Setting

1. Use app to configure settings on each EBQ.

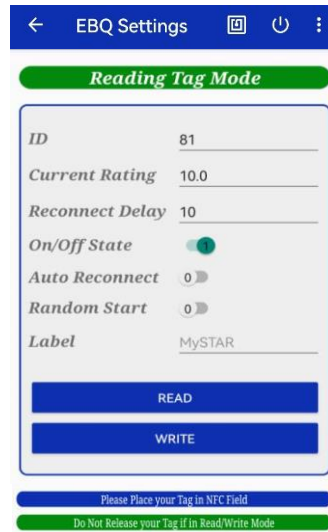

**ID** – ID for each EBQ. **NOTE: No repeating IDs**

**Current Rating (A)** – Desired cut off current.

**Reconnect Delay (s)** – Period between cut off to Auto reconnect.

**On/Off State** – N/A

**Auto Reconnect** – N/A

**Label** – Purposes for user records.

1. After filling up the settings, click 'Write'.
2. If successful, the pop-up 'Write Success' will appear.
3. Click 'Read' to read back the new settings.

### EBQ Programmer

1. Use app to bootload each EBQ.

**MAILBOX IS DISABLED.**

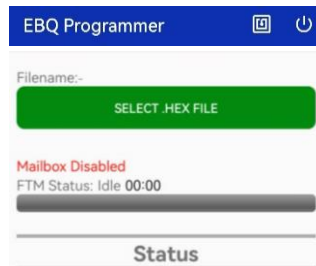

2. Select .HEX file.

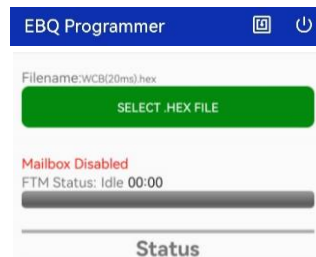

- Place EBQ near phone.
- Apps start to scanning EBQ.

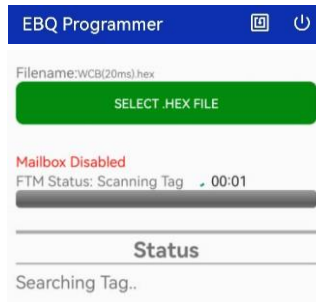

- EBQ detected. Wait for the connection to be established.  
**MAILBOX IS ENABLED.**

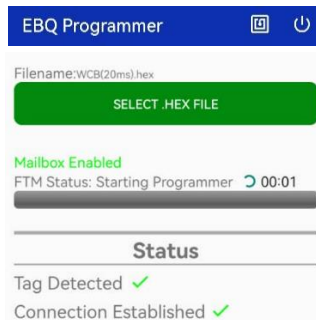

- Wait until the download is complete.

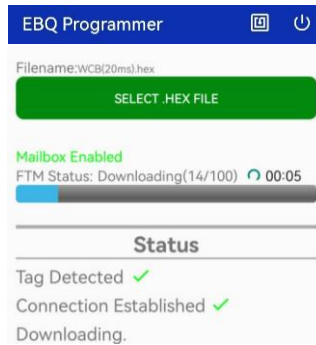

- Completed. EBQ is ready to use.

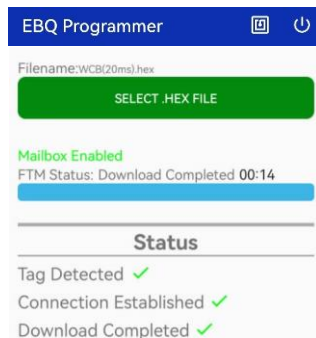

## EBQ Control

- 1) Connect to your EBQ Master.



- 2) All connected EBQ can be seen in the app.

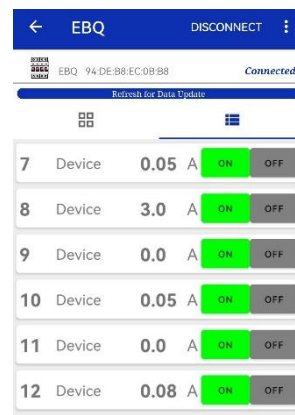

## **OPERATION**

### **Setting up**

1. Mount the EBQ DIN Rail to the wall.
2. Mount the main controller unit to the wall or normal DIN rail.
3. Connect the EBQ DIN Rail to the main controller unit by Ethernet cable. (Cable < 3meters)
4. Place the EBQ units to the EBQ DIN Rail
5. Connect the Live IN and Out wires to the EBQ unit.
6. Power ON Main Controller Unit.

### **Initial Power Up**

1. After 30s after the Main Controller Unit is powered on, red LED will start flashing. (1 minute waiting required for the first time powered on, while 2 minutes for the >16A model)
2. Red LED indicates that EBQ is charging and functioning but still not in operating mode.
3. After roughly another 30 seconds, relay contact closes.
4. Red LED stop blinking.
5. Green LED start blinking.
6. Green LED indicates that EBQ is fully charged and allows for normal operation.

### **LED Operation**

1. Green LED flashing indicates EBQ in ON mode.
2. Red LED flashing indicates EBQ in OFF mode.
3. Fast Red LED flashing indicates EBQ detects over current.

### **Overcurrent**

1. Current measurement slightly above the current setting.
2. Green LED continue to blink normally.
3. Red LED start to blink from slow to fast.

**NOTE: The higher the current measurement, the faster the red LED blinks and shorter the time needed for relay to cut off.**

4. Relay contact open.
5. Green LED stop blinking.
6. Red LED light up for 1.5 secs.
7. Red LED start flashing.

### **Short Circuit**

1. Current measurement way beyond the current setting.
2. Relay contact open.
3. Green LED stop blinking.
4. Red LED light up for 1.5 secs.
5. Red LED start blinking.

### **Button Operation**

1. Short key press on Button will make the EBQ to flash blue LED.
2. If the EBQ is OFF, long key press(>2seconds). Will switch ON the EBQ
3. If the EBQ is ON, long key press(>2seconds). Will switch OFF the EBQ



## **EBQ Removal**

- 1) EBQ removed from EBQ Din Rail under normal operation.
- 2) Relay contact open.
- 3) LED will stop flashing,
- 4) EBQ placed back onto EBQ Din Rail.
- 5) If the EBQ was ON before removal, it will be ON when returns to the EBQ DIN rail, and the green LED will continue to flash.
- 6) If the EBQ was OFF before removal, it will be OFF when returns to the EBQ DIN rail, and the red LED will continue to flash.

## **EBQ on/off behaviour**

- 1) When EBQ is away from the RF DIN rail, it will be powered off.
- 2) When RF DIN Rail/ EBQ master is off, EBQ will be powered off.
- 3) When powered off, the EBQ will be automatically open circuit.
- 4) The EBQ will memorize the on/off status upon powered off, and it will follow the status before powered off.

### **Example:**

- EBQ in open circuit -> power off -> 1 hour -> power on -> EBQ in open circuit
- EBQ in close circuit -> power off -> 1 hour -> power on -> EBQ in close circuit

## **OVER CURRENT CUT OFF TABLE**

<b>Current</b>	<b>30sec</b>	<b>5sec</b>	<b>Short</b>
<b><u>C</u></b>	<b><u>C+2.0+10%</u></b>	<b><u>C+4+15%</u></b>	<b><u>10+2.5C</u></b>
<b><u>2.0</u></b>	<b><u>4.2</u></b>	<b><u>6.3</u></b>	<b><u>15.0</u></b>
<b><u>4.0</u></b>	<b><u>6.4</u></b>	<b><u>8.6</u></b>	<b><u>20.0</u></b>
<b><u>6.0</u></b>	<b><u>8.6</u></b>	<b><u>10.9</u></b>	<b><u>25.0</u></b>
<b><u>8.0</u></b>	<b><u>10.8</u></b>	<b><u>13.2</u></b>	<b><u>30.0</u></b>
<b><u>10.0</u></b>	<b><u>13.0</u></b>	<b><u>15.5</u></b>	<b><u>35.0</u></b>
<b><u>12.0</u></b>	<b><u>15.2</u></b>	<b><u>17.8</u></b>	<b><u>40.0</u></b>
<b><u>14.0</u></b>	<b><u>17.4</u></b>	<b><u>20.1</u></b>	<b><u>45.0</u></b>
<b><u>16.0</u></b>	<b><u>19.6</u></b>	<b><u>22.4</u></b>	<b><u>45.0</u></b>
			-
<b><u>(40A Model)</u></b>	-	-	<b><u>10+2.0C</u></b>
<b><u>18.0</u></b>	<b><u>21.8</u></b>	<b><u>24.7</u></b>	<b><u>46.0</u></b>
<b><u>20.0</u></b>	<b><u>24.0</u></b>	<b><u>27.0</u></b>	<b><u>50.0</u></b>
<b><u>22.0</u></b>	<b><u>26.2</u></b>	<b><u>29.3</u></b>	<b><u>54.0</u></b>
<b><u>24.0</u></b>	<b><u>28.4</u></b>	<b><u>31.6</u></b>	<b><u>58.0</u></b>
<b><u>26.0</u></b>	<b><u>30.6</u></b>	<b><u>33.9</u></b>	<b><u>62.0</u></b>
<b><u>28.0</u></b>	<b><u>32.8</u></b>	<b><u>36.2</u></b>	<b><u>66.0</u></b>
<b><u>30.0</u></b>	<b><u>35.0</u></b>	<b><u>38.5</u></b>	<b><u>70.0</u></b>
<b><u>32.0</u></b>	<b><u>37.2</u></b>	<b><u>40.8</u></b>	<b><u>70.0</u></b>
<b><u>34.0</u></b>	<b><u>39.4</u></b>	<b><u>43.1</u></b>	<b><u>70.0</u></b>
<b><u>36.0</u></b>	<b><u>41.6</u></b>	<b><u>45.4</u></b>	<b><u>70.0</u></b>
<b><u>38.0</u></b>	<b><u>43.8</u></b>	<b><u>47.7</u></b>	<b><u>70.0</u></b>
<b><u>40.0</u></b>	<b><u>46.0</u></b>	<b><u>50.0</u></b>	<b><u>70.0</u></b>